

CRS43-01



CRS43-02 and CRS43-04



Features

- High performance single axis MEMS gyroscope
- 5th generation VSG technology
- Dynamic Range $\pm 100^\circ/\text{s}$ and $\pm 200^\circ/\text{s}$
- 4.75 to 5.25V supply
- Wide operating temperature range -40°C to $+85^\circ\text{C}$
- Three model types available including; Pin version for PCB mounting Flying lead version for chassis mounting
- Excellent performance over temperature
- Repeatable drift characteristic
- Low noise
- High shock and vibration operation
- High reliability
- Metalised housing
- Low-cost CRS03 'drop-in' alternative
- RoHS compliant

Applications

- Antenna and Platform Stabilisation
- Precision Agriculture
- Autonomous vehicles and ROVs
- Attitude measurement systems
- Personal navigation
- GPS drop-out Aiding

1 General Description

A robust and affordable mass-produced gyroscope for Industrial and Commercial applications.

Angular rate sensors are used wherever rate of turn sensing is required without a fixed point of reference. The sensor will output a DC voltage proportional to the rate of turn and input voltage.

High performance motion sensing even under severe shock and vibration.

CRS43 has been developed to offer existing CRS03 customers a low cost, 'drop-in' alternative. Silicon Sensing's highly successful VSG5 (fifth generation Vibrating Structure ring Gyroscope) precision MEMS provides the core angular rate sensing element.

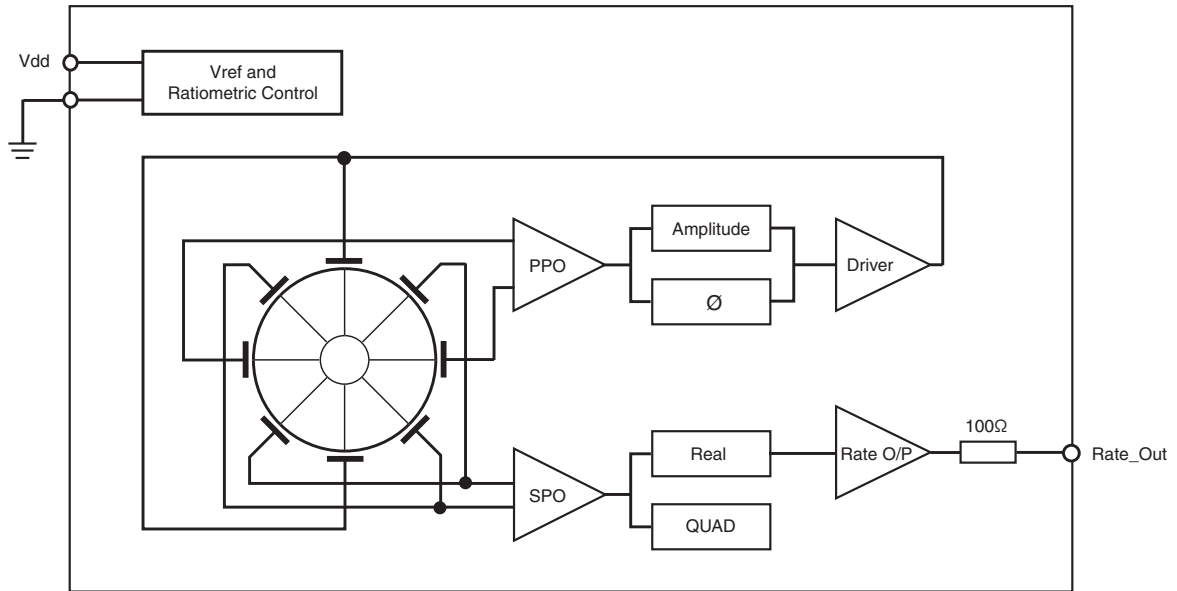

C.G.18724

Figure 1.1 CRS43 Functional Block Diagram

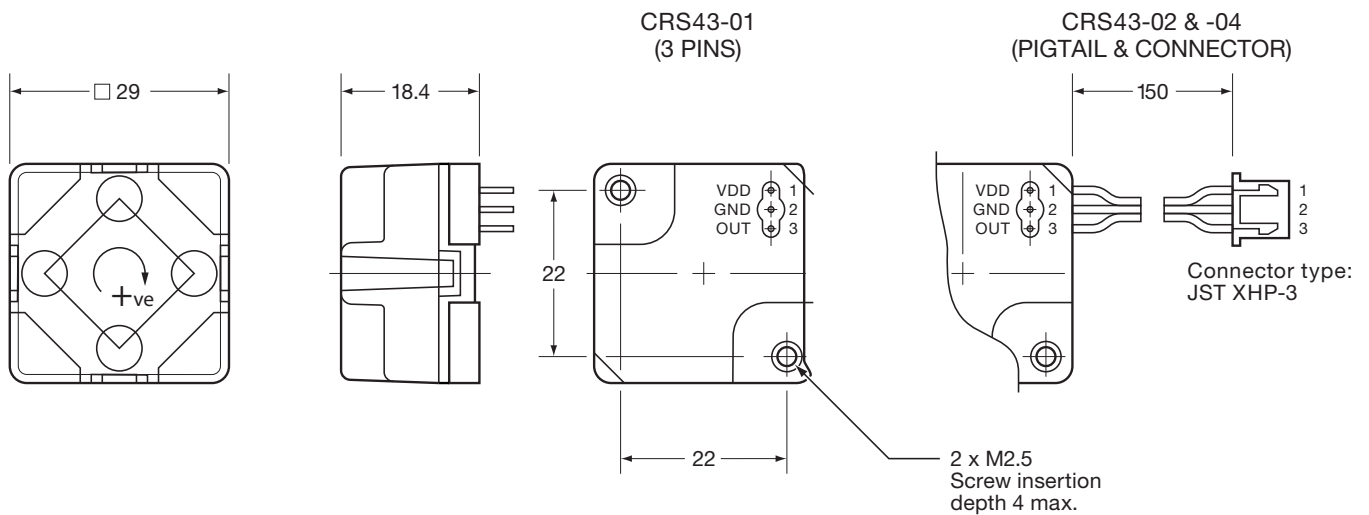

All dimensions in millimetres.

Figure 1.2 CRS43-01, CRS43-02 and CRS43-04 Overall Dimensions

2 Ordering Information

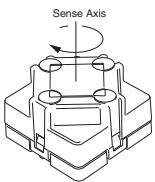
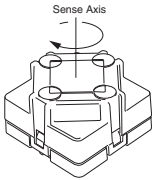
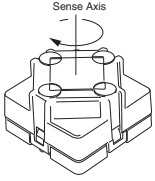
Part Number	Sense Axis	Description	Measurement Range	Output	Interface	Overall Dimensions	Supply Voltage
			°/s	mV/°/s		mm	V
CRS43-01		Single Axis Angular Rate Sensor, ±100°/s	±100°/s	Analogue, 20mV/°/s (Ratiometric)	Three Pins, nominal protrusion, 4.3mm (±0.3mm)	29 x 29 x 18.4	4.75 - 5.25
CRS43-02		Single Axis Angular Rate Sensor, ±100°/s			Flying Lead, nominal length 150mm (±10mm)		
CRS43-04		Single Axis Angular Rate Sensor, ±200°/s	±200°/s	Analogue, 10mV/°/s (Ratiometric)			

CRS03 Equivalent

CRS43 is a lower-cost, 'drop-in' Form, Fit and Function alternative to Silicon Sensing's CRS03 angular rate sensor. Customers who are using the CRS03 sensor may find that they switch to the new CRS43 sensor with a minimum of new engineering.

CRS03 Part	Equivalent CRS43 Part
CRS03-01S/-01T	CRS43-01
CRS03-02S/-02T	CRS43-02
CRS03-04S	CRS43-04
CRS03-05S	Not available
CRS03-11S	Not available

3 Specification

Unless otherwise specified, the following specification values assume Vdd (Supply Voltage) is between 4.75 and 5.25V with an ambient temperature of between -40°C and +85°C.

Part Number CRS43-01 and CRS43-02				
Parameter	Minimum	Typical	Maximum	Notes
Measurement Range	–	±100°/s	–	–
Scale Factor error at +25°C	-3%	±1%	+3%	Nominal Scale Factor is 20mV/°/s
Scale Factor variation with temperature	-5%	±3%	+5%	Percentage of measurement, range using a best straight line fit
Scale Factor ratiometric error	-1%	–	+1%	–
Scale Factor non linearity	-3%	<±0.5%	+3%	Percentage of full scale measurement range
Bias (nominal), at +25°C	-60mV	–	+60mV	Output nominally at 50% of Vdd
Bias variation with temperature	-60mV	–	+60mV	–
Bias ratiometric error	-20mV	–	+20mV	–
Quiescent Noise (rms)	–	–	0.6mV	Cumulative noise, wide band
Bandwidth	10Hz	24Hz	–	-3dB
Cross-axis sensitivity	–	–	<5%	–
Bias drift	–	–	1.1°/s	In any 30s period after start up

3 Specification Continued

Part Number CRS43-04				
Parameter	Minimum	Typical	Maximum	Notes
Measurement Range	–	±200°/s	–	–
Scale Factor error at +25°C	-3%	±1%	+3%	Nominal Scale Factor is 10mV/°/s
Scale Factor variation with temperature	-5%	±3%	+5%	Percentage of measurement, range using a best straight line fit
Scale Factor ratiometric error	-1%	–	+1%	–
Scale Factor non linearity	-3%	<±0.5%	+3%	Percentage of full scale measurement range
Bias (nominal), at +25°C	-60mV	–	+60mV	Output nominally at 50% of Vdd
Bias variation with temperature	-30mV	–	+30mV	–
Bias ratiometric error	-20mV	–	+20mV	–
Quiescent Noise (rms)	–	–	0.6mV	Cumulative noise, wide band
Bandwidth	10Hz	24Hz	–	-3dB
Cross-axis sensitivity	–	–	<5%	–
Bias drift	–	–	1.1°/s	In any 30s period after start up

4 Power Requirements

Parameter	Minimum	Typical	Maximum	Notes
Start up time	–	–	0.5s	From point where Vdd rises above and remains above 4.5V
Current dissipation	–	26mA	50mA	<170mA when starting up
Output Impedance	–	100Ω	–	–
Operating supply voltage	4.75V	5V	5.25V	For full performance
Absolute maximum positive supply voltage	0V	5V	6.00V	Applied voltages outside this range may damage the device
Supply current	–	26mA	50mA	–

5 Typical Performance Characteristics

Graphs showing typical performance characteristics for CRS43 are below.

Note: Typical data is with the device powered from a 5.0V supply, unless stated otherwise.

CRS43-01 Characteristics

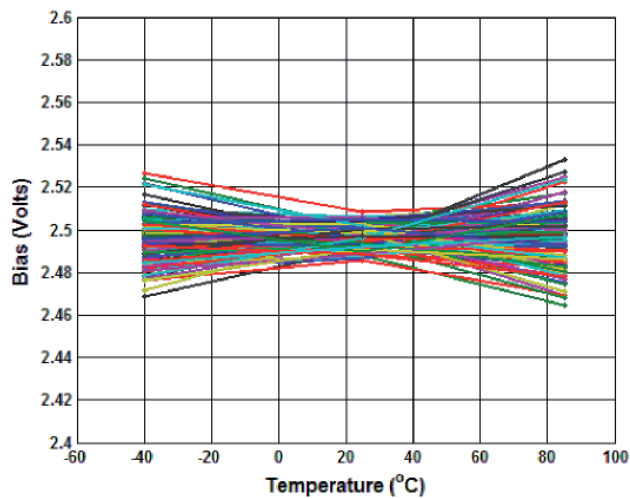

Figure 5.1 CRS43-01 Bias (Volts) vs Temperature

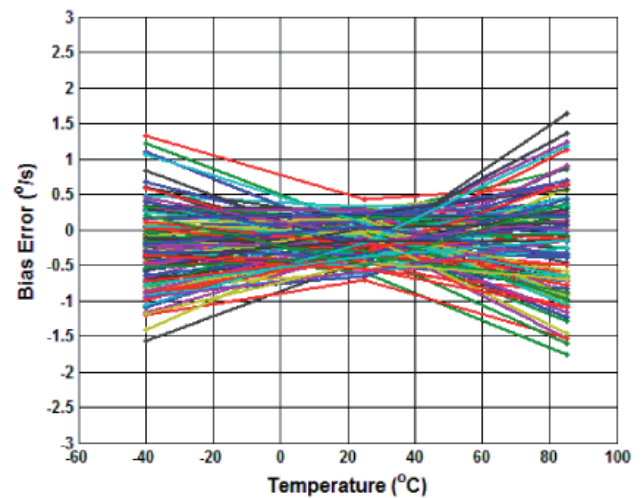

Figure 5.2 CRS43-01 Bias (dps) vs Temperature

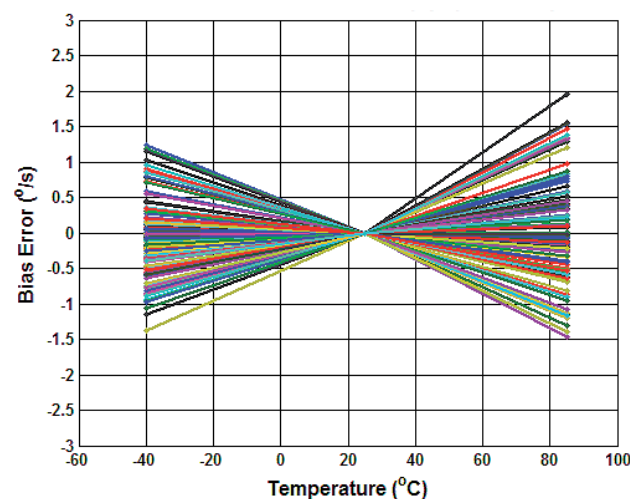

Figure 5.3 CRS43-01 Normalised Bias Error (dps) vs Temperature

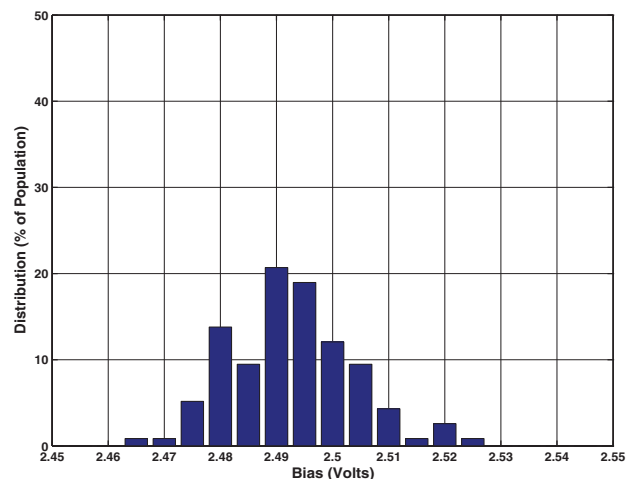

Figure 5.4 CRS43-01 Bias at -40°C

CRS43-01 Characteristics

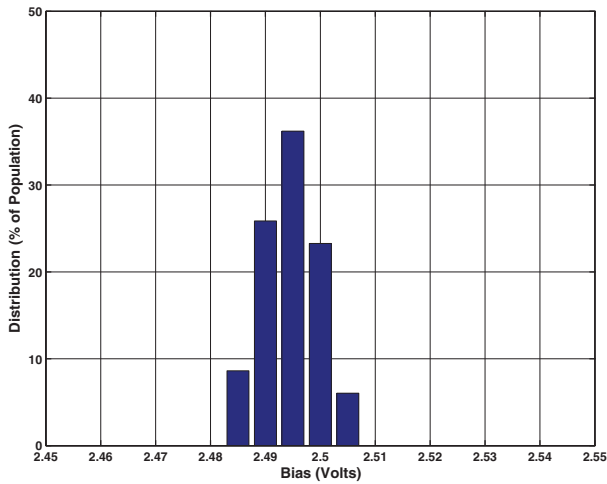

Figure 5.5 CRS43-01 Bias at 23°C

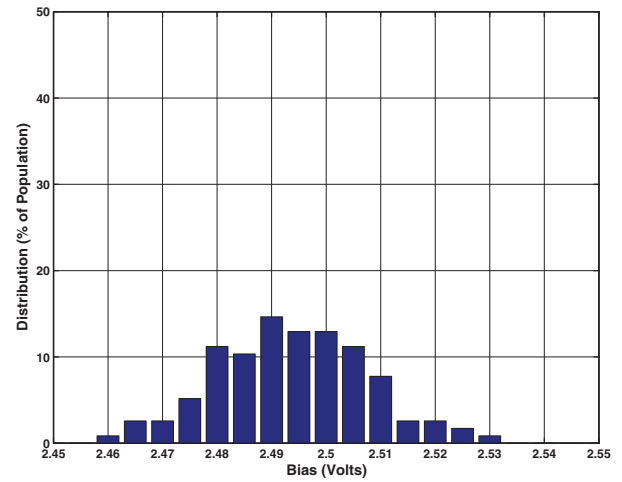

Figure 5.6 CRS43-01 Bias at 85°C

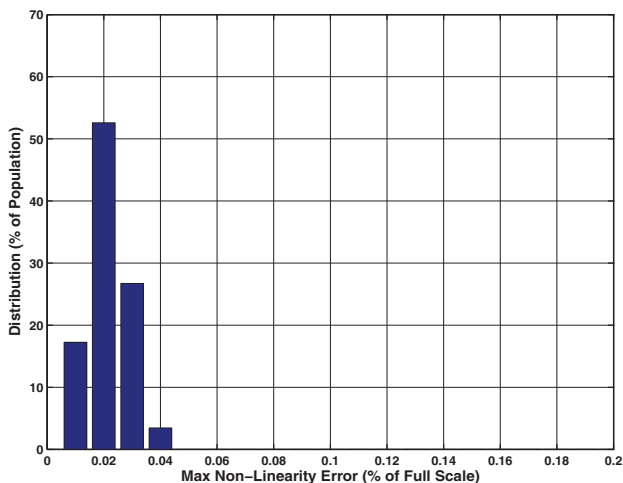

Figure 5.7 CRS43-01 Max Linear Error (%) at 25°C

CRS43-02 Characteristics

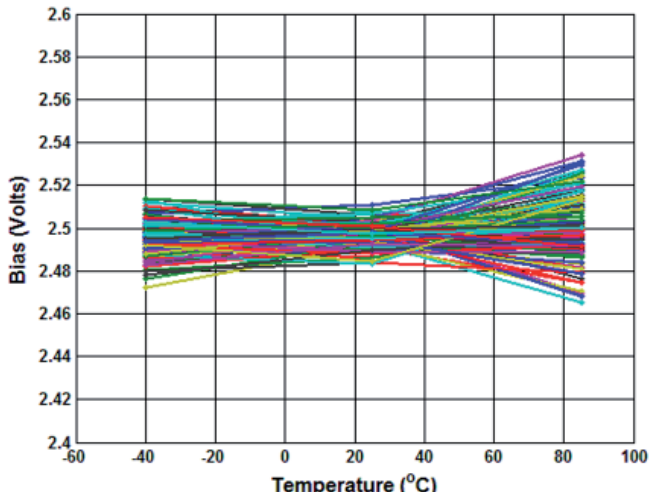

Figure 5.8 CRS43-02 Bias (Volts) vs Temperature

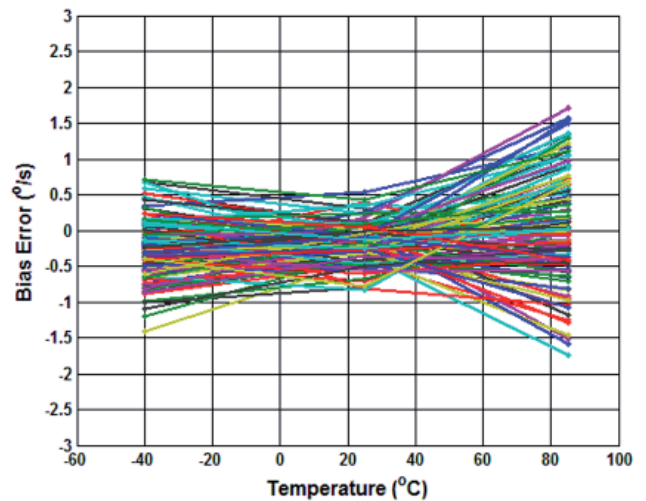

Figure 5.9 CRS43-02 Bias Error (dps) vs Temperature

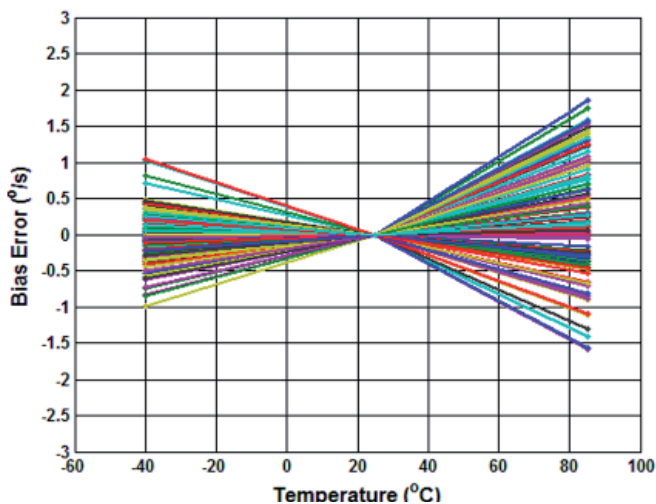

Figure 5.10 CRS43-02 Normalised Bias Error (dps) vs Temperature

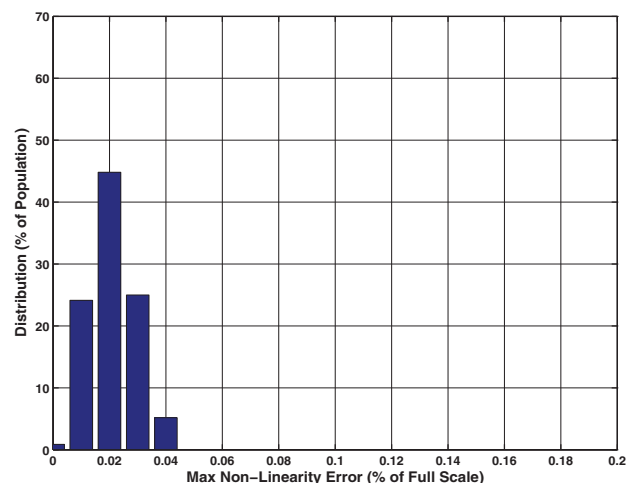

Figure 5.11 CRS43-02 Max Linear Error (%) at 25°C

CRS43-04 Characteristics

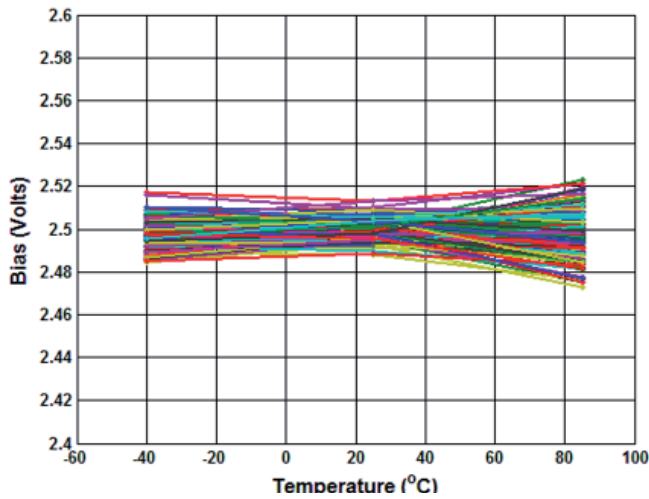

Figure 5.12 CRS43-04 Bias (Volts) vs Temperature

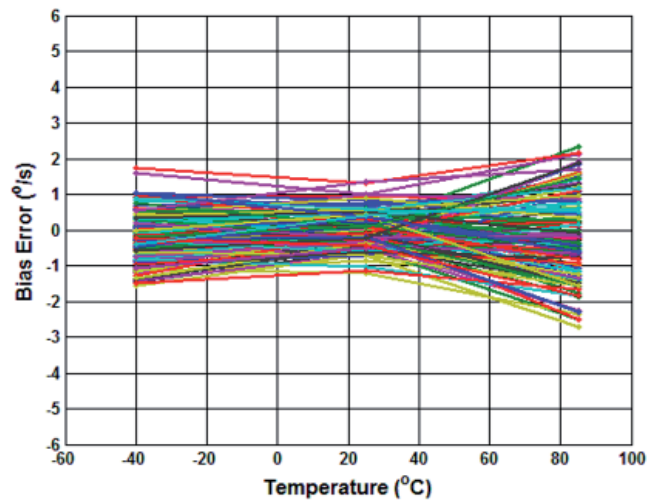

Figure 5.13 CRS43-04 Bias Error (dps) vs Temperature

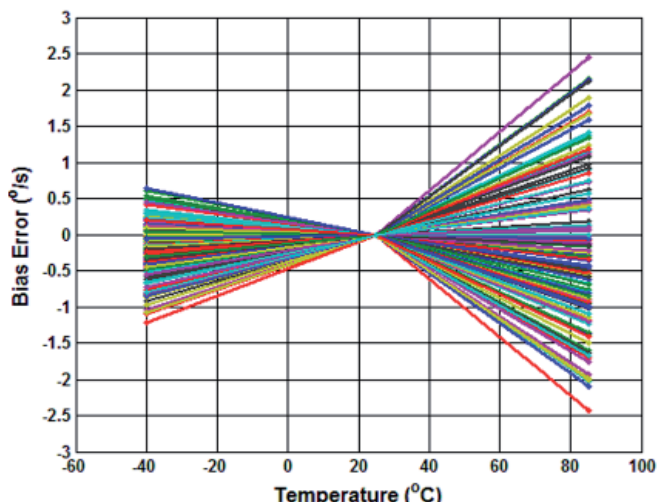

Figure 5.14 CRS43-04 Normalised Bias Error (dps) vs Temperature

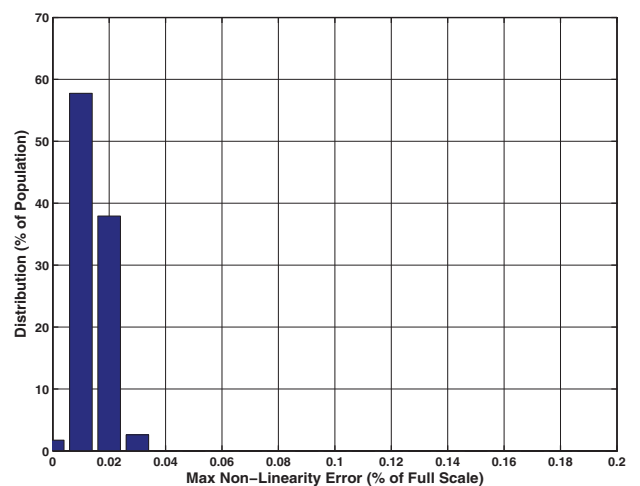

Figure 5.15 CRS43-04 Max Linear Error (%) at 25°C

6 Operating and Storage Environment

Parameter	Minimum	Typical	Maximum	Notes
G sensitivity	-	-	0.2°/s/g ²	-
Vibration Rectification Error, VRE	-	-	0.003°/s/g ²	20Hz - 2KHz, random vibration
Random vibration	-	10g	-	20Hz - 2KHz
Sine sweep (peak)	-	5g	-	15Hz - 2KHz
Shock	-	200g	-	1mS 1/2 Sine
Relative humidity	5%	-	85%	Non-condensing
Mass	-	26mA	50mA	-
Operating temperature range	-40°C	23°C	+85°C	-
Storage temperature range	-40°C	23°C	+85°C	-
ESD (HBM, air discharge)	-	±2kV	-	At +25°C

7 Interfacing

7.1 Installation Details

The CRS43 module has a plastic moulded two-part housing which is metalised on the exterior surface. It is recommended that the casing is isolated from the system. In the base of the CRS43 there are two brass female screw inserts which are intended to be used by the customer to affix the CRS43 module to the host application. The screws thread is M2.5 and the maximum recommended insertion length is 4mm, further insertion may cause damage to the CRS43.

CRS43-01 is fitted with three electrical interface pins which project from the underside of the base of the CRS43 and which can be soldered into through-holes in the host application PCBA. Care should be taken when handling CRS43-01 to prevent damage to or bending of the interface pins.

CRS43-02 and -04 parts have a short (approximately 150mm) 'pigtail' flying lead which is terminated using a demountable connector (JST XHP-3).

The following electrical pin out configuration is used:

Part Number	Pin Function
1	Vdd
2	Ground
3	Rate_Out

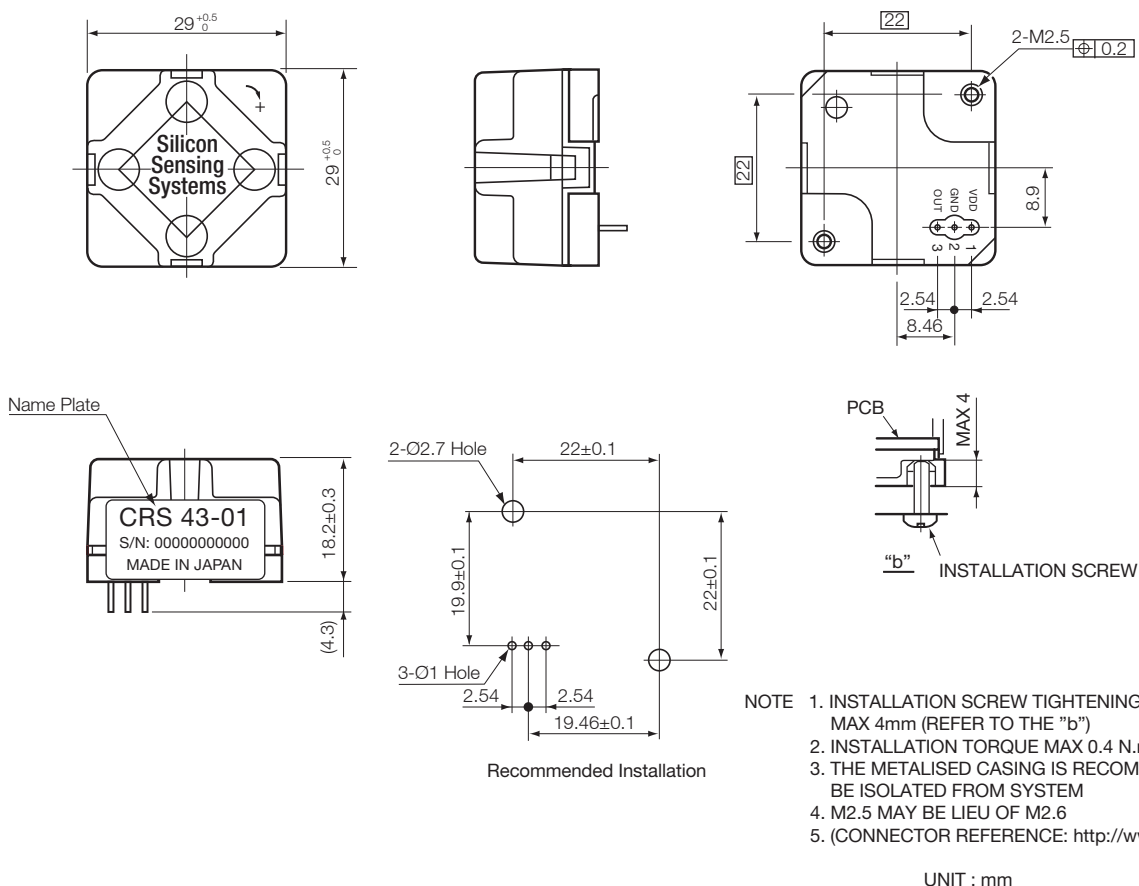

Figure 7.1 CRS43-01 Interface and Overall Dimensions

CRS43 Technical Datasheet

Single Axis Angular Rate Sensor



www.siliconsensing.com

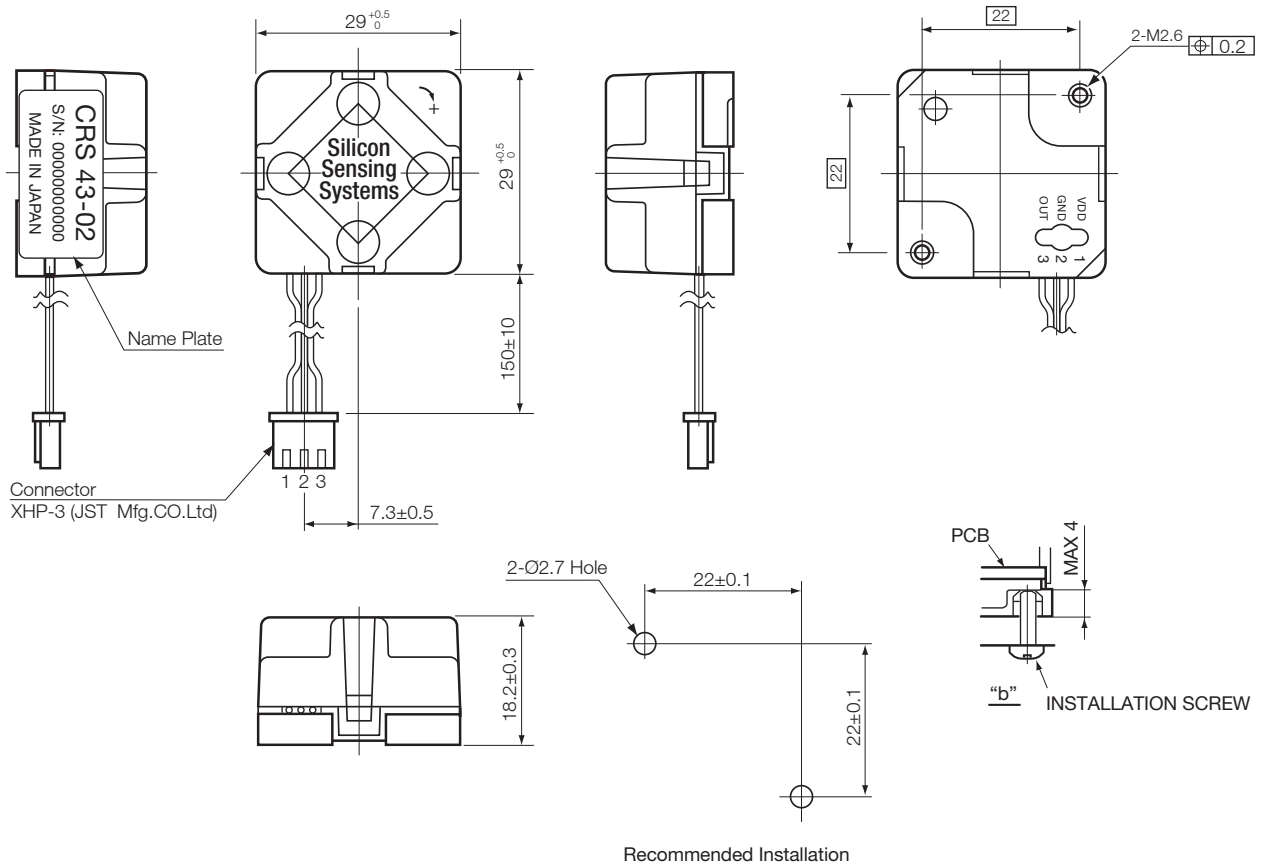

Recommended Installation

- NOTE
1. INSTALLATION SCREW TIGHTENING LENGTH
MAX 4mm (REFER TO THE "b")
 2. INSTALLATION TORQUE MAX 0.4 N.m
 3. THE METALISED CASING IS RECOMMENDED TO
BE ISOLATED FROM SYSTEM
 4. M2.5 MAY BE LIEU OF M2.6
 5. (CONNECTOR REFERENCE: <http://www.jst-mfg.com/>)

UNIT : mm

Figure 7.2 CRS43-02 and -04 Interface and Overall Dimensions

7.2 Typical Rate Output

The output from CRS43 is ratiometric. The output will therefore be different for different applied voltages. The relationship between the CRS43 output and the applied supply voltage is:

$$V_o = \frac{1}{2} \times V_{dd} + \left(Ra \times SF \times \frac{V_{dd}}{5} \right); \text{ (Unit: Volt typ.)}$$

Where: V_o : Rateout (V), V_{dd} : Supply voltage (V), Ra : Applied rate (deg/s), SF : Scale Factor (V/(deg/s)).

7.3 Bias Ratiometric Error

Bias ratiometric error are calculated as follows:

$$Errb = V_b - \left(V_{b_5} \times \frac{V_{dd}}{5} \right) \text{ (V)}$$

Where: $Errb$: Bias ratiometric error (V), V_b : Bias at V_{dd} (V), V_{b_5} : Bias at 5.00V (V), V_{dd} : Supply voltage (V).

7.4 Scale Factor Ratiometric Error

Scale Factor ratiometric error are calculated as follows:

$$Errs = \left[SF - \left(SF_5 \times \left(\frac{V_{dd}}{5} \right) \right) \right] \times \frac{100}{SF} \text{ (\%)}$$

Where: $Errs$: Scale Factor ratiometric error (%), SF : Scale Factor at V_{dd} (V/(deg/s)), SF_5 : Scale Factor at 5.00V (V), V_{dd} : Supply voltage (V).

7.5 Soldering

The CRS43 must not be subjected to temperatures outside that specified for Storage Temperature at any time. When soldering is necessary then hand soldering is recommended. Solder reflow chambers must not be used.

8 Glossary of Terms

ADC	Analogue to Digital Converter
ARW	Angle Random Walk
AWG	American Wire Gauge
BPS	Bits Per Second (or Baud Rate)
BW	Bandwidth
C	Celsius or Centigrade
DAC	Digital to Analogue Converter
DPH	Degrees Per Hour
DPS	Degrees Per Second
DRIE	Deep Reactive Ion Etch
EMC	Electro-Magnetic Compatibility
ESD	Electro-Static Damage
F	Farads
h	Hour
HBM	Human Body Model
Hz	Hertz, Cycles Per Second
K	Kilo
MDS	Material Datasheet
MEMS	Micro-Electro Mechanical Systems
mV	Mili-Volts
NEC	Not Electrically Connected
NL	Scale Factor Non-Linearity
OEM	Original Equipment Manufacturer
OT	Over Temperature
PD	Primary Drive
PP	Primary Pick-Off
RC	Resistor and Capacitor filter
RT	Room Temperature
s	Seconds
SF	Scale Factor
SMT	Surface Mount Technology
SOG	Silicon On Glass
SD	Secondary Drive
SP	Secondary Pick-Off
T.B.A.	To Be Advised
T.B.D.	To Be Determined
V	Volts

9 Part Markings

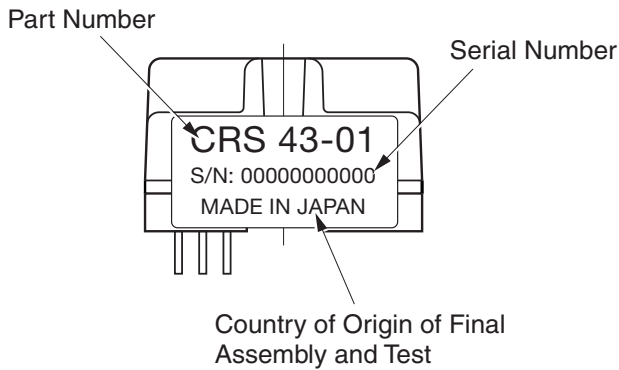

10 Internal Construction and VSG5 Theory of Operation

Construction

CRS43 incorporates Silicon Sensing's latest VSG5 (5th generation Vibrating Structure Gyroscope) thin-film PZT MEMS vibrating ring technology. The VSG5 sensor chip is mounted on a single PCBA together with associated power supply and conditioning electronics.

The VSG5 Sensor comprises five main components; silicon MEMS ring Sensor, Silicon Pedestal, ASIC and the Package Base and Lid. The MEMS ring Sensor, ASIC and Pedestal are housed in a hermetically sealed package cavity with a nitrogen back-filled partial vacuum, this has particular advantages over sensors supplied in plastic packages which have Moisture Sensitivity Level limitations.

Theory of Operation

VSG5 is a solid-state device and thus has no moving parts other than the deflection of the ring itself. It detects the magnitude and direction of angular velocity by using the 'coriolis force' effect. As the gyro is rotated coriolis forces acting on the silicon ring cause radial movement at the ring perimeter.

There are eight actuators/transducers distributed evenly around the perimeter of the silicon MEMS ring. Located about its primary axes (0° and 90°) are a single pair of 'primary drive' actuators and a single pair of 'primary pick-off' transducers. Located about its secondary axes (45° and 135°) are two pairs of 'secondary pick-off' transducers.

The 'primary drive' actuators and 'primary pick-off' transducers act together in a closed-loop system to excite and control the ring primary operating vibration amplitude and frequency (22kHz).

Secondary 'pick-off' transducers detect radial movement at the secondary axes, the magnitude of which is proportional to the angular speed of rotation and from which the gyro derives angular rate. The transducers produce a double sideband, suppressed carrier signal, which is demodulated back to a baseband, the width of which is controlled by the user by one simple external capacitor. This gives the user complete flexibility over in system performance, and makes the transduction completely independent of DC or low frequency parametric conditions of the electronics.

Referring to Figures 10.3(a) to 10.3(d)

Figure 10.3(a) shows the structure of the silicon MEMS ring. Figure 10.3(b) shows the ring diagrammatically, the spokes, actuators and transducers removed for clarity, indicating the Primary Drive actuators (single pair), Primary Pick-Off transducers (single pair) and Secondary Pick-Off transducers (two pairs).

In Figure 10.3(b) the annular ring is circular and is representative of the gyro when unpowered.

When powered-up the ring is excited along its primary axes using the Primary Drive actuators and Primary Pick-Off transducers acting in a closed-loop control system within the ASIC. The circular ring is deformed into a 'Cos2θ' mode which is elliptical in form and has a natural frequency of 22kHz. This is depicted in Figure 10.3(c). In Figure 10.3(c) the gyro is powered-up but still not rotating. At the four Secondary Pick-Off nodes located at 45° to the primary axes on the ring perimeter there is effectively no radial motion.

If the gyro is now subjected to applied angular rate, as indicated in Figure 10.3(d), then this causes the ring to be subjected to coriolis forces acting at a tangent to the ring perimeter on the primary axes. These forces in turn deform the ring causing radial motion at the Secondary Pick-Off transducers. It is the motion detected at the Secondary Pick-off transducers which is proportional to the applied angular rate.

The DSBSC signal is demodulated with respect to the primary motion, which results in a low frequency component which is proportional to angular rate.

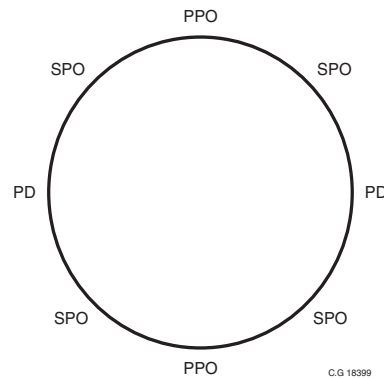

Figure 10.3(b)

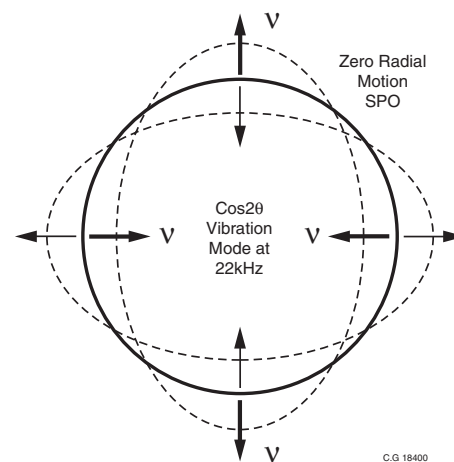

Figure 10.3(c)

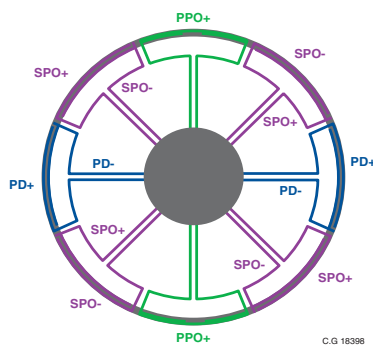

Figure 10.3(a)

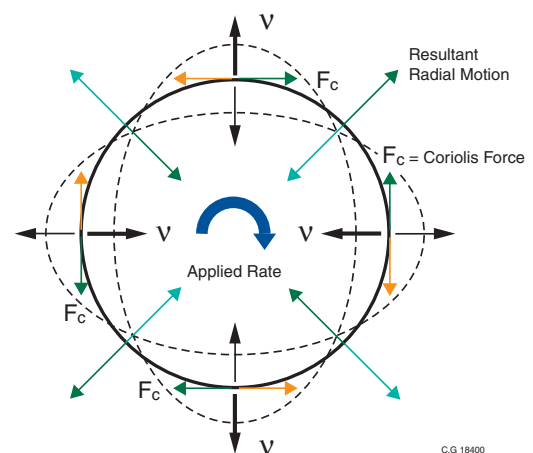

Figure 10.3(d)

CRS43

Technical Datasheet

Single Axis Angular Rate Sensor



www.siliconsensing.com

Notes

CRS43

Technical Datasheet

Single Axis Angular Rate Sensor

**SILICON
SENSING** 

www.siliconsensing.com

Notes

Silicon Sensing Systems Limited
Clifford Road Southway
Plymouth Devon
PL6 6DE United Kingdom
T: +44 (0)1752 723330
F: +44 (0)1752 723331
E: sales@siliconsensing.com
W: siliconsensing.com

Silicon Sensing Systems Japan Limited
1-10 Fuso-Cho
Amagasaki
Hyogo 6600891 Japan
T: +81 (0)6 6489 5868
F: +81 (0)6 6489 5919
E: sssj@spp.co.jp
W: siliconsensing.com

Specification subject to change without notice.

© Copyright 2016
Silicon Sensing Systems Limited
All rights reserved.

Printed in England 02/2016
Date 16/02/2016

CRS43-00-0100-132 Rev 2
DCR No. 710009468