

# CRH03 Series Technical Datasheet

High Performance Analogue Angular Rate Sensor

**SILICON SENSING** 

www.siliconsensing.com

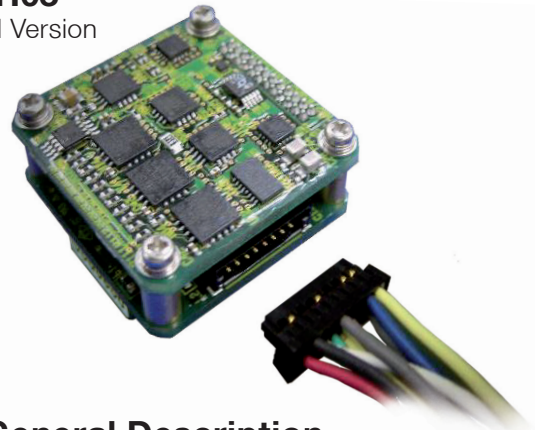
## CRH03

Housed Version



## CRH03

OEM Version



## Features

- Fibre Optic Gyro (FOG) like performance
- Small size
- Proven and Robust silicon MEMS VSG3Q<sup>MAX</sup> vibrating ring structure with improved balancing
- Five rate ranges available:  $\pm 10^\circ/\text{s}$ ,  $\pm 25^\circ/\text{s}$ ,  $\pm 100^\circ/\text{s}$ ,  $\pm 200^\circ/\text{s}$  and  $\pm 400^\circ/\text{s}$
- Low bias instability -  $0.04^\circ/\text{hr}$  ( $100^\circ/\text{s}$ )
- Excellent angle random walk -  $0.006^\circ/\sqrt{\text{hr}}$  ( $100^\circ/\text{s}$ )
- Low noise -  $0.12^\circ/\text{s rms}$  ( $100^\circ/\text{s}$ )
- Precision analogue output
- High shock and vibration rejection
- Precise thermal compensation
- Approximately half noise reduction against previous model CRH02
- Warm-up drift reduction against previous model CRH02
- RoHS Compliant
- Low current compensation compared to CRH02

## Applications

- Aerospace Applications
- Platform Stabilisation
- Precision Surveying
- Maritime Guidance and Control
- Gyro-compassing and Heading Control
- Autonomous Vehicles and ROVs
- Rail Track monitoring
- Robotics
- Drilling Equipment and Guidance
- Inertial Measurement Units

## 1 General Description

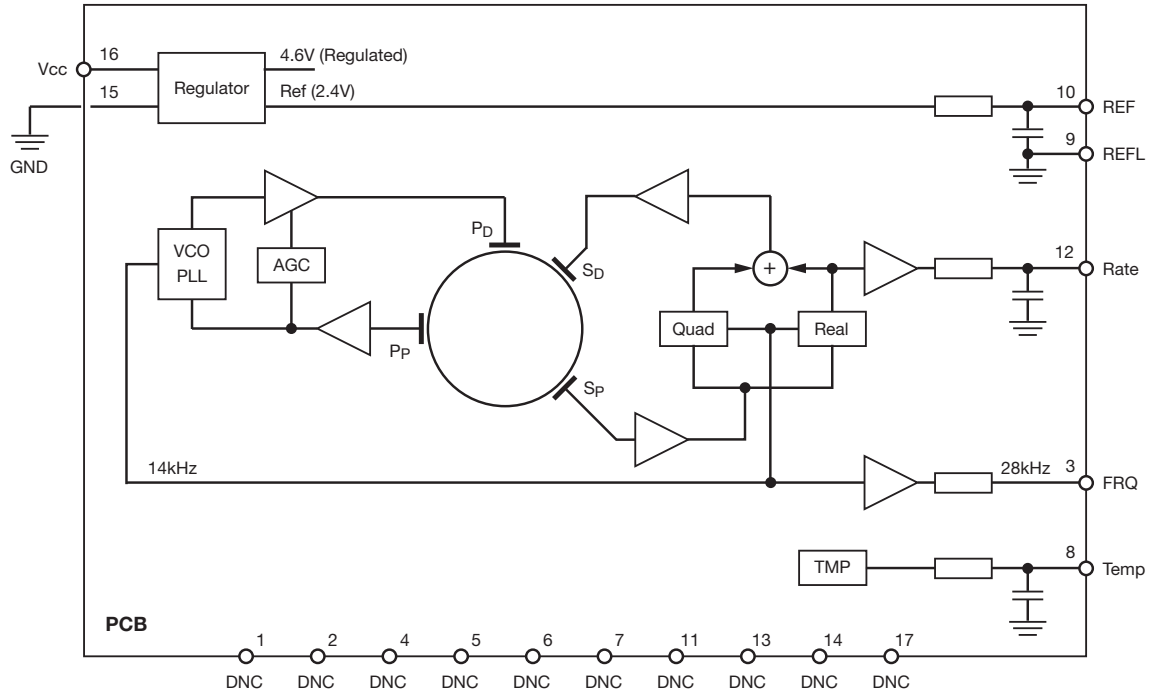
CRH03 provides the optimum solution for applications where bias instability, angle random walk and low noise are of critical importance.

CRH03 uses the latest generation of Silicon Sensing's proven MEMS resonating structure with an improved balancing technique that optimises operation in  $\cos 2\theta$  vibrating mode. The mechanical structure and mode of operation make CRH03 extremely robust and tolerant to external vibration.

For multi-axis applications, CRH03 is available in 3 frequency ranges (V, L and M) to minimise cross axis interference. There is no difference in function, performance or interface between the frequency variants. The CRH03 variants are listed in the table below.

MEMS Type	Frequency Output
V-Type	<27.37 (kHz)
L-Type	27.37~27.83 (kHz)
M-Type	>27.83 (kHz)

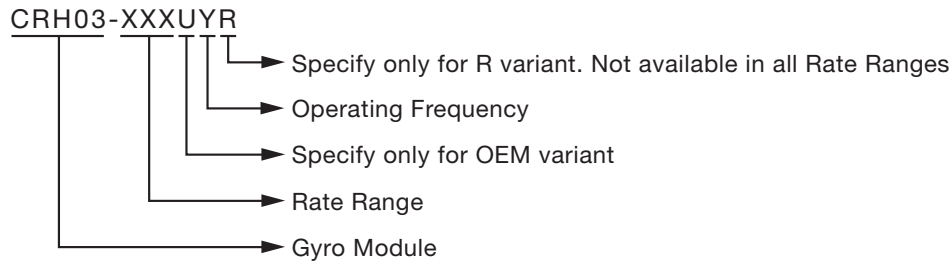
Additional temperature compensation can be applied to CRH03 by a host system and the R variant, which provides raw and uncompensated output can be used in this application. An on board temperature sensor is provided to support this. The resonant frequency of the MEMS may also be used to determine temperature.



C.G.18916

**Figure 1.1 CRH03 Functional Block Diagram**

## 2 Ordering Information



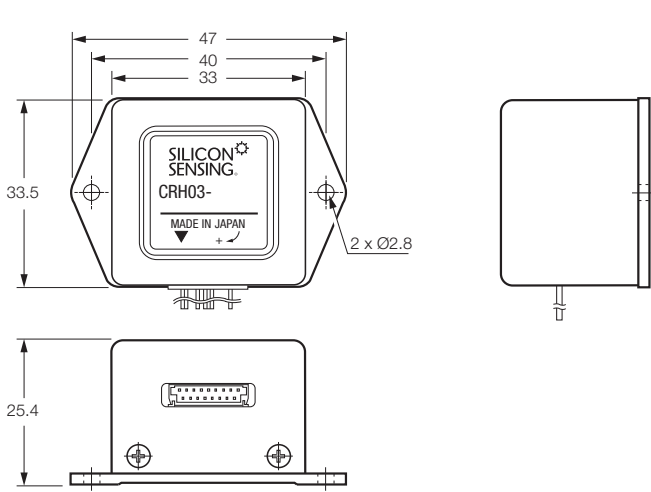
C.G.18897

**Figure 2.1 Ordering Part Number Definition**

Part Number	Rate Range	Housed Version		OEM Version		
		L	V	L	M	R
CRH03-010	±10°/s	√	√	√	√	-
CRH03-025	±25°/s	√	√	√	√	-
CRH03-100	±100°/s	√	√	√	√	-
CRH03-200	±200°/s	√	√	√	√	√
CRH03-400	±400°/s	√	√	√	√	√

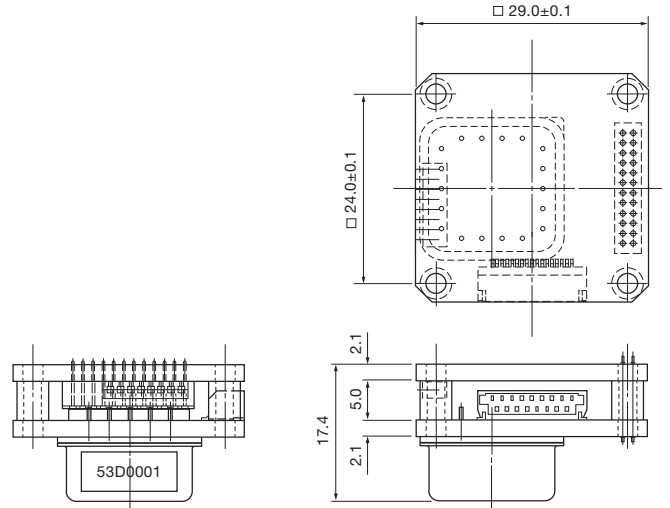
**Table 2.1 Ordering Information**

### 3 Mechanical Detail



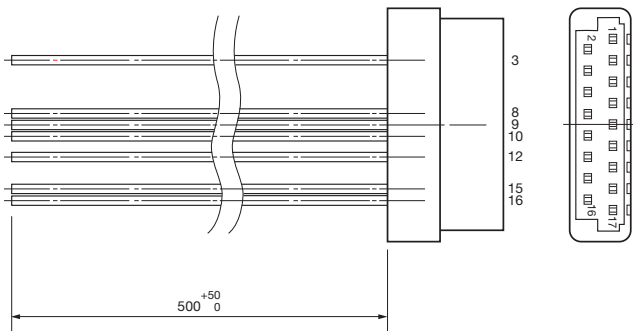
All dimensions in millimetres.

**Figure 3.1 CRH03 (Housed Version) Overall Dimensions**



C.G. 18890

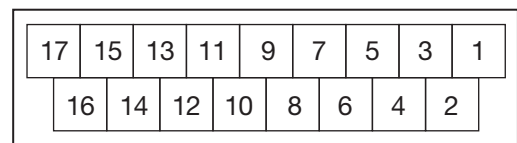
**Figure 3.2 CRH03 (OEM Version) Overall Dimensions**



C.G. 18891

(Accessory cable is included only with the housed version of CRH03.)

**Figure 3.3 Accessory Cable**



C.G. 18892

**Figure 3.4 Connector Terminal Number (Mating Surface View)**

# CRH03 Series Technical Datasheet

High Performance Analogue Angular Rate Sensor



www.siliconsensing.com

## 4 Specification

Unless stated otherwise, the following specification values assume V<sub>dd</sub> = 4.85 to 5.25V and an ambient temperature of +25°C. "Over temperature" refers to the temperature range -40°C to +85°C.

Parameter	Minimum	Typical	Maximum	Notes	
<b>Characteristic</b>					
Rate Range	CRH03-010	±10°/s		–	
	CRH03-025	±25°/s		–	
	CRH03-100	±100°/s		–	
	CRH03-200	±200°/s		–	
	CRH03-400	±400°/s		–	
Scale Factor at 25°C	CRH03-010	199.0mV/°s	200.0mV/°s	201.0mV/°s	–
	CRH03-025	79.6mV/°s	80.0mV/°s	80.4mV/°s	–
	CRH03-100	19.9mV/°s	20.0mV/°s	20.1mV/°s	–
	CRH03-200	9.95mV/°s	10.0mV/°s	10.05mV/°s	–
	CRH03-400	4.975mV/°s	5.00mV/°s	5.025mV/°s	–
Scale Factor Variation Over Temperature with respect to RT (25°C)	CRH03-010	–	±0.15%	±0.5% (±10%)	–
	CRH03-025				
	CRH03-100	–	±0.3% (±5%)		(For R versions)
	CRH03-200				
CRH03-400					
CRH03-400					
Scale Factor Non-Linearity	CRH03-010	–	±0.02%	±0.05%	–
	CRH03-025				
	CRH03-100				
	CRH03-200				
	CRH03-400				
Bias at 25°C		–	–	±10mV	With respect to REF
Bias Over Temperature with respect to RT (25°C)	CRH03-010	–	±0.1°/s	±0.2°/s	–
	CRH03-025				
	CRH03-100	–	±0.15°/s	±0.25°/s	–
	CRH03-200				
CRH03-400					
Warm-up Drift at 25°C		–	10°/hr (0.027°/s)	–	–
Angular Random Walk at 25°C	CRH03-010	–	0.005°/√hr	–	Section 8.7
	CRH03-025	–	0.006°/√hr	–	
	CRH03-100	–	0.006°/√hr	–	
	CRH03-200	–	0.008°/√hr	–	–
	CRH03-400	–	0.010°/√hr	–	–

### 4 Specification Continued

Parameter		Minimum	Typical	Maximum	Notes
<b>Characteristic</b>					
Bias Instability at 25°C	CRH03-010	–	0.03°/hr	–	Section 8.8
	CRH03-025	–	0.04°/hr	–	
	CRH03-100	–	0.04°/hr	–	
	CRH03-200	–	0.05°/hr	–	–
	CRH03-400	–	0.10°/hr	–	–
Quiescent Noise	CRH03-010	–	0.050°/s rms	–	3~50Hz
	CRH03-025	–	0.050°/s rms	–	3~50Hz
	CRH03-100	–	0.12°/s rms	–	3~100Hz
	CRH03-200	–	0.12°/s rms	–	3~100Hz
	CRH03-400	–	0.12°/s rms	–	3~100Hz
Bandwidth	CRH03-010	–	50Hz	–	–
	CRH03-025	–	50Hz	–	–
	CRH03-100	–	100Hz	–	–
	CRH03-200	–	100Hz	–	–
	CRH03-400	–	100Hz	–	–
Reference Output	2.380V	2.400V	2.420V	With respect to REFL	
Minimum Output Current	500µA	–	–	–	
Temperature Sensor Scale Factor	–	-11.7mV/°C	–	–	
Start Up Time	–	–	750ms	–	
<b>Physical</b>					
Mass (Housed Version)	–	42 grams	–	–	
Mass (OEM Version)	–	18 grams	–	–	
Cross Axis Sensitivity	–	–	3%	–	
<b>Environmental</b>					
Temperature (Operating)	-40°C	–	85°C	–	
Temperature (Storage)	-40°C	–	100°C	–	
Humidity	–	–	95%	Non-condensing	
Linear Acceleration Sensitivity	–	0.02°/s/g	–	–	
Shock (Operating)	–	–	95g x 6ms	–	
Shock (Powered Survival)	–	–	1,000g x 1ms	–	
Vibration Rectification Error	–	0.002°/s/g <sup>2</sup> rms	–	10-2,000Hz 10g rms	
Vibration Induced Noise	–	0.01°/s rms/g <sup>2</sup> rms	–	10-2,000Hz 10g rms	
MTTF	–	70,000hr	–	–	

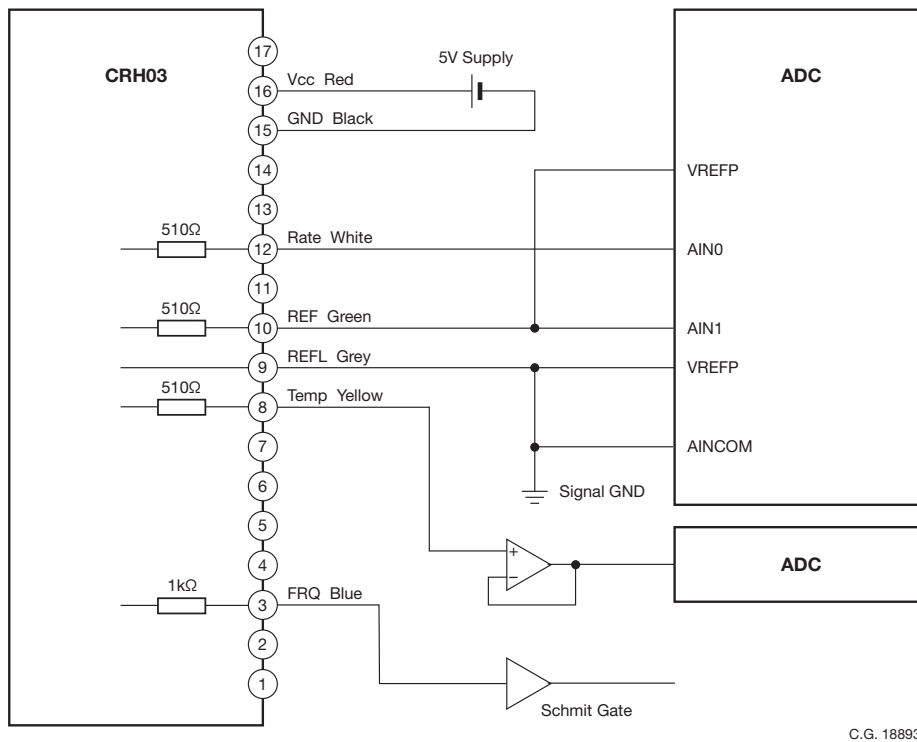
### 4 Specification Continued

Parameter	Minimum	Typical	Maximum	Unit	Notes
<b>Electrical</b>					
Supply Voltage (Functional)	4.75	–	5.25	V	Section 8.1
Supply Voltage (Full Specification)	4.85	–	5.25	V	
Current Consumption	–	30	40	mA	–

### 5 Absolute Maximum

Parameter	Minimum	Maximum
<b>Electrical</b>		
Supply Voltage	–	6.0V
ESD Protection	–	2kV HBM

### 6 Interface



C.G. 18893

**Figure 6.1 Recommended Peripheral Connection**

## 6 Interface Continued

Pin Number	Pin Name	Signal Direction (I/O)	Function
3	FRQ	Output	Second harmonic resonating ring frequency output
8	Temp	Output	Temperature output with respect to REF
9	REFL	–	Reference Low voltage
10	REF	Output	Reference voltage datum for rate, Temp
12	Rate	Output	Rate voltage with respect to REF
15	GND	–	Power ground
16	Vcc	–	Power supply to sensor
1, 2, 4, 5, 6, 7, 11, 13, 14, 17	DNC	–	Do not connect (SSS internal use)

### 6.1 Auxiliary Output Signals

Parameter	Minimum	Typical	Maximum	Notes
<b>Frequency</b>				
Resonating Ring Frequency	27kHz	28.0kHz	29kHz	Output impedance 1kohm
Frequency Temperature Coefficient	-0.9Hz/°C	-0.80Hz/°C	-0.7Hz/°C	–
<b>Temperature</b>				
Temperature Sensor Offset at 0°C	–	-0.536V	–	With respect to REF output impedance 510ohm
Temperature Sensor Offset at 25°C	–	-0.830V	–	With respect to REF output impedance 510ohm
Temperature Sensor Scale Factor	-12.60mV/°C	-11.77mV/°C	-11.00mV/°C	Output impedance 510ohm

**Note 1:** The angle random walk is the value derived at the intercept of the - 1/2 tangent on the Allan Variance plot and the 1 second correlation point (tau) divided by 60.

**Note 2:** The bias instability is the value at the minimum part of the Allan Variance plot, usually between 10s and 100s.

**Note 3:** The product must not be subjected to temperatures outside the recommended storage temperature range at any time.

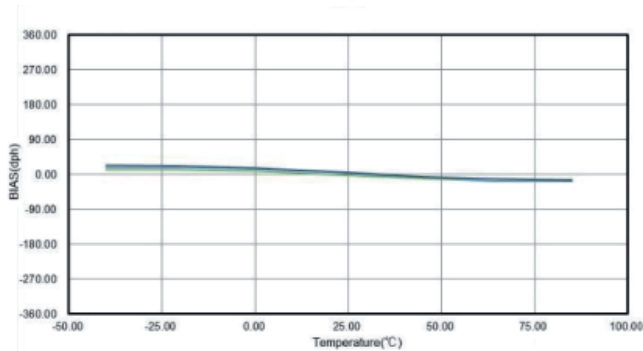
**Note 4:** CRH03 is a precision measurement instrument. Do not drop onto a hard surface from a height exceeding 200mm.

### 7. Typical Performance Characteristics

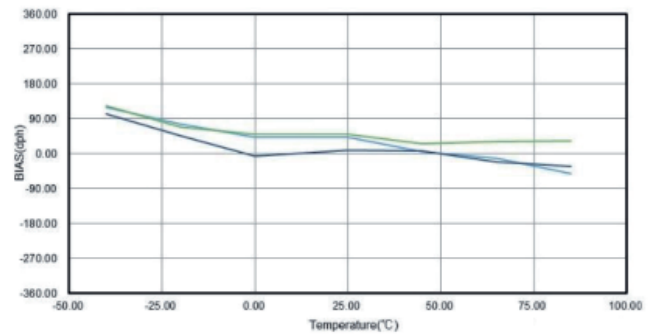
This section shows the typical performance of CRH03, supplied with a 5.0V supply unless stated otherwise.

#### 7.1 Bias Characteristics

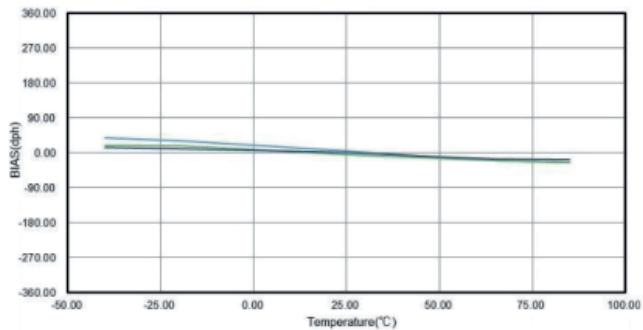
This section shows typical bias variation over temperature with respect to the bias at +25°C.



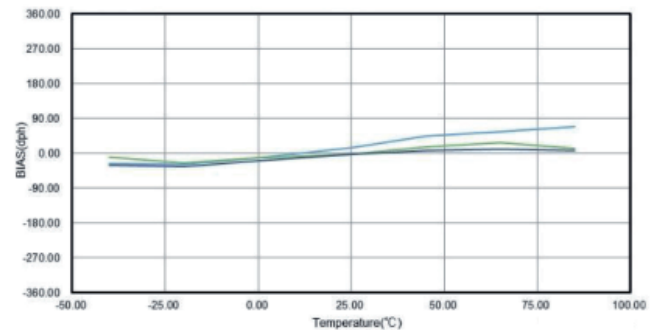
**Figure 7.1 CRH03-010 Bias Performance (w.r.t. 25°C)**



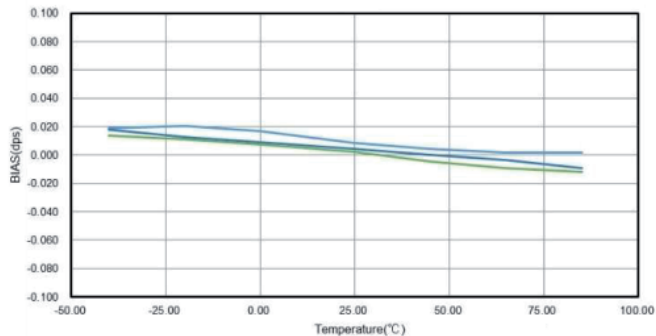
**Figure 7.4 CRH03-200 Bias Performance (w.r.t. 25°C)**



**Figure 7.2 CRH03-025 Bias Performance (w.r.t. 25°C)**



**Figure 7.5 CRH03-400 Bias Performance (w.r.t. 25°C)**

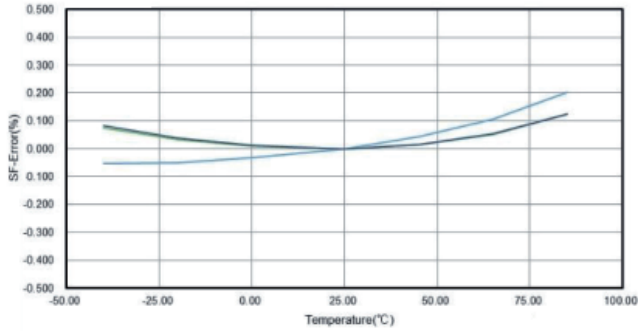


**Figure 7.3 CRH03-100 Bias Performance (w.r.t. 25°C)**

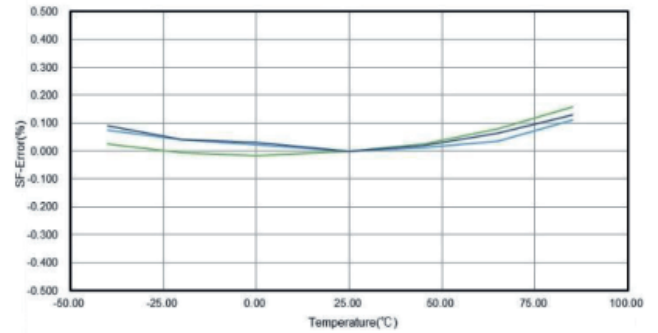


### 7.2 Scale Factor Characteristics

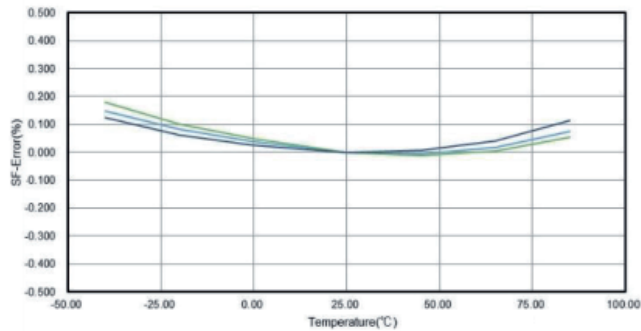
This section shows the typical scale factor variation over temperature, with respect to the scale factor at +25°C



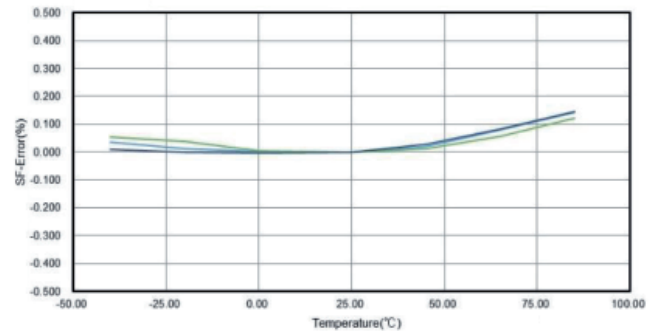
**Figure 7.6 CRH03-010 SF Performance (w.r.t. 25°C)**



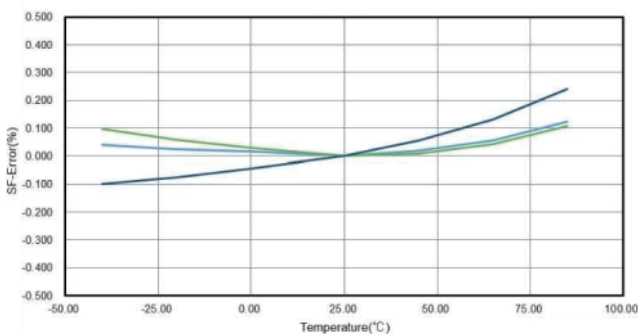
**Figure 7.9 CRH03-200 SF Performance (w.r.t. 25°C)**



**Figure 7.7 CRH03-025 SF Performance (w.r.t. 25°C)**

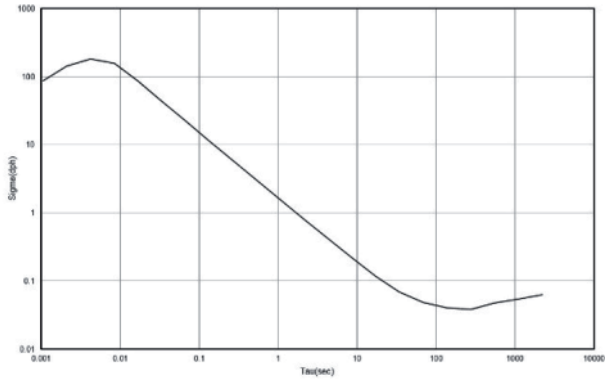


**Figure 7.10 CRH03-400 SF Performance (w.r.t. 25°C)**

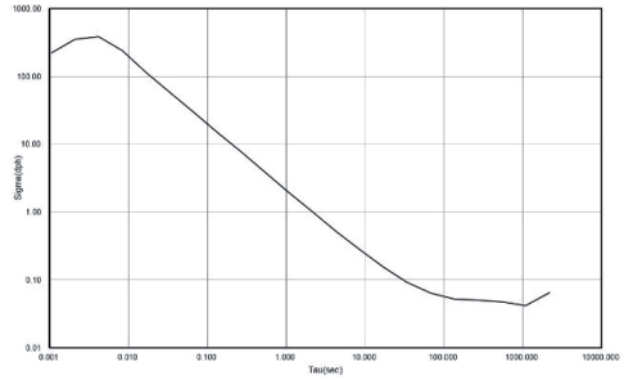


**Figure 7.8 CRH03-100 SF Performance (w.r.t. 25°C)**

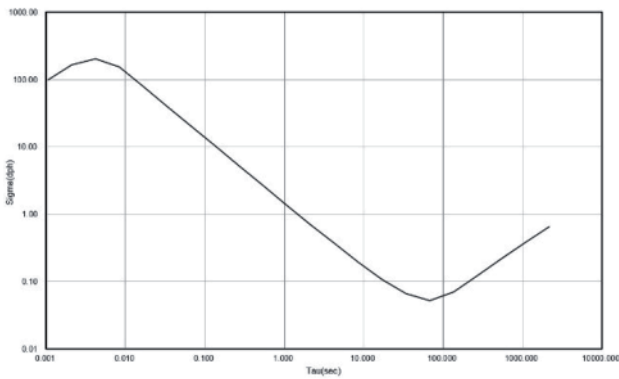
### 7.3 Reference Performance Data for Allan Variance



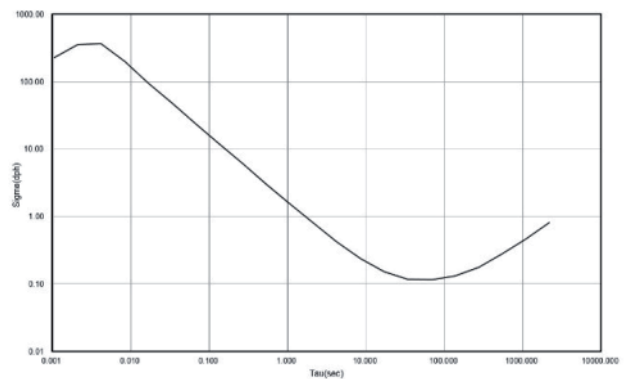
**Figure 7.11 CRH03-010 Allan Variance Performance (w.r.t. 25°C)**



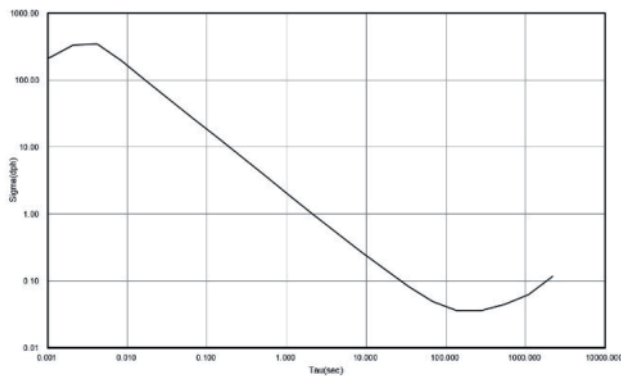
**Figure 7.14 CRH03-200 Allan Variance Performance (w.r.t. 25°C)**



**Figure 7.12 CRH03-025 Allan Variance Performance (w.r.t. 25°C)**



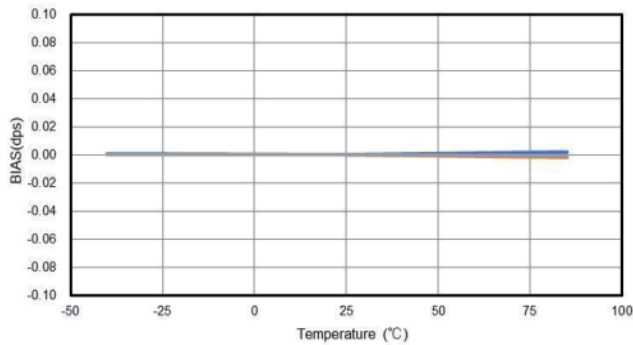
**Figure 7.15 CRH03-400 Allan Variance Performance (w.r.t. 25°C)**



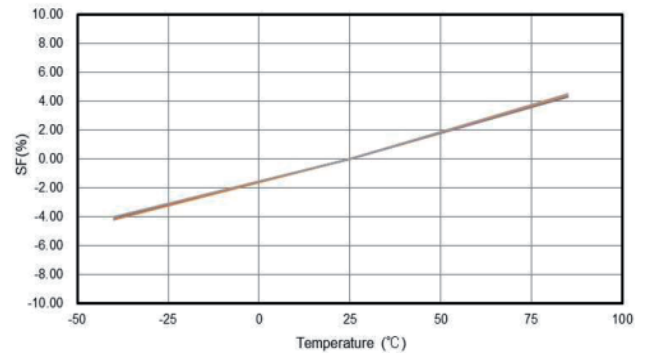
**Figure 7.13 CRH03-100 Allan Variance Performance (w.r.t. 25°C)**

### 7.4 Reference Performance Data for Bias for R Version

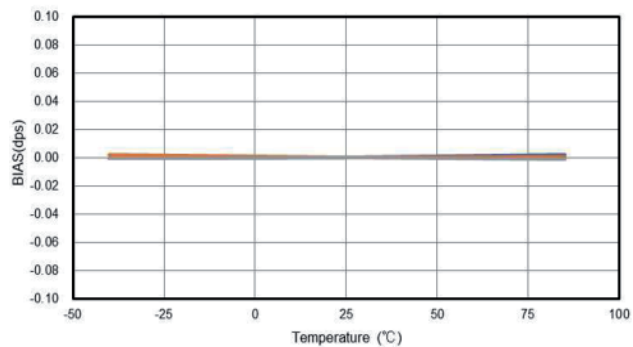
### 7.5 Reference Performance Data for Scale Factor for R Version



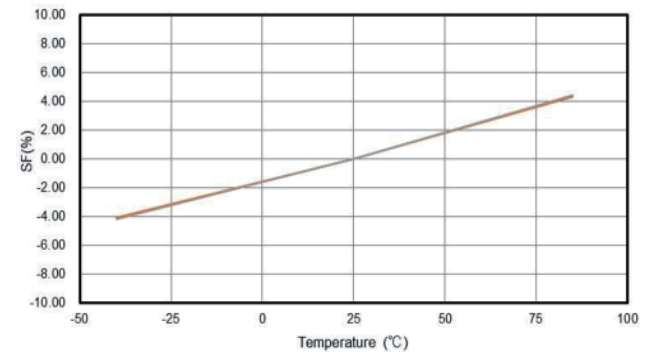
**Figure 7.16 CRH03-200UxR Bias Performance (w.r.t. 25°C)**



**Figure 7.18 CRH03-200UxR SF Performance (w.r.t. 25°C)**



**Figure 7.17 CRH03-400UxR Bias Performance (w.r.t. 25°C)**

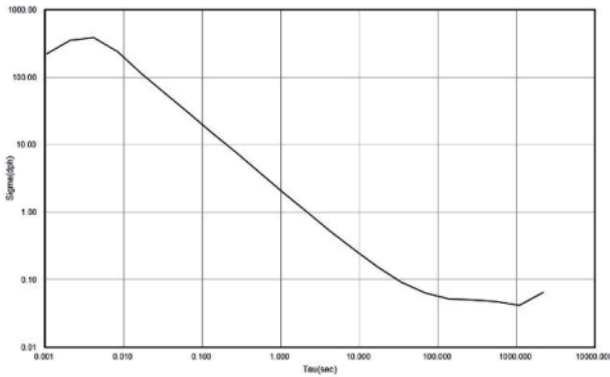


**Figure 7.19 CRH03-400UxR SF Performance (w.r.t. 25°C)**

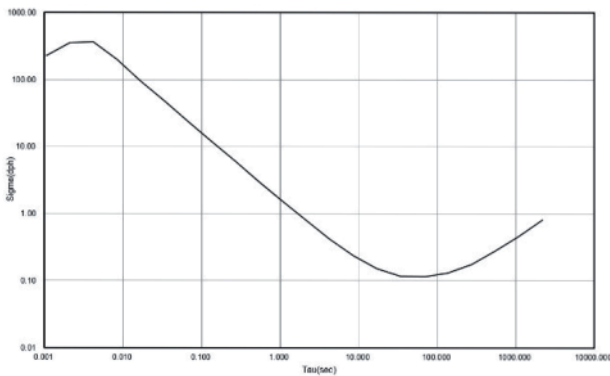
**Note:** Each figure showed 3 samples data. The vertical axis of above figures (Bias data) is half of the production limit.

**Note:** Each figure showed 3 samples data. The vertical axis of above figures (SF data) is half of the production limit.

### 7.6 Reference Performance Data for Allan Variance for R Version



**Figure 7.20 CRH03-200UxR Allan Variance Performance (w.r.t. 25°C)**



**Figure 7.21 CRH03-400UxR Allan Variance Performance (w.r.t. 25°C)**

### 8 Other Information

#### 8.1 Supply Voltage

CRH03's rate output is non-ratiometric meaning that it is independent of supply voltage, provided it is operated within the specified voltage range.

The supply voltage, including ripple and power supply noise, must not fall below 4.85V in order to maintain full performance.

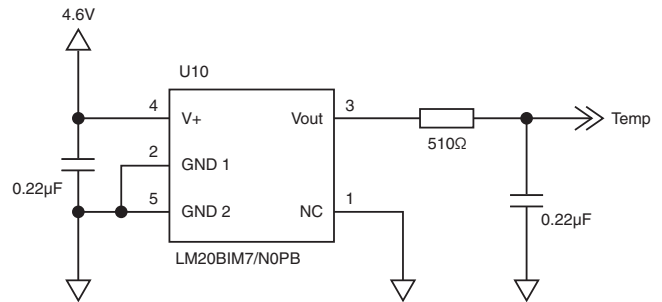
The voltage ramp up speed at power up shall be less than 40ms for voltage ramp up to reach +4.85V. If the ramp up speed is longer, there is a possibility for the CRH03 to have a start-up error.

#### 8.2 Mating Cable Assembly

An accessory cable (Figure 3.3) is supplied only with the Housed version of CRH03. For spares, or if an accessory cable is required for the OEM version, please contact Silicon Sensing for ordering information.

#### 8.3 Temperature Sensor

The temperature sensor uses a LM20B device, internally connected as shown in Figure 8.1.



C.G.18731

**Figure 8.1 Temperature Sensor**

The output at 0°C is typically +1.864V with respect to REFL. The temperature coefficient is typically -11.77mV/°C.

The output can be measured with respect to REFL or can be put through a differential input instrumentation amplifier, referenced to the REF pin, in which case the offset at 0°C is typically -0.536V. At +25°C, the output is typically -0.830V with respect to REF. The temperature sensor is not intended for use as a thermometer, since they are not calibrated on the Celsius scale. They are intended only as a temperature reference for thermal compensation techniques.

### 8.4 Rate and Ref Outputs

Both the Rate and the REF outputs are protected by a resistor before the output pins. The resistor value is 510ohms.

It is important to take these resistor values into account when calculating the gains of external differential amplifiers. It is also recommended that the REF signal is buffered if it is used as a reference for more than one signal.

It is recommended that the Rate Output is differentially sensed using a precision instrumentation amplifier, referenced to the REF output. A reference Low (0V), REFL is also provided as a ground reference for external ADCS (see Figure 6.1).

The Offset of the instrumentation amplifier should be derived from the host stage (e.g. derived from the ADC REF Voltage) or from the signal ground if the following stage is an analogue stage.

### 8.5 Frequency Outputs

This is a CMOS Digital (74HC series) compatible digital output running at twice the frequency of the sensor head. It is provided to give an indication of the temperature of the sensor. The nominal frequency is 28kHz with a typical temperature coefficient of  $-0.8\text{Hz}/^\circ\text{C}$ .

The signal is protected with a 1kohm resistor and It is recommended that it is buffered with a CMOS Schmitt Gate such as 74HC12, or TC7S14F. By monitoring the change in frequency of this signal, an accurate measure of the internal temperature of the sensor can be determined. This can be used for compensation purposes.

An example of measuring the MEMS temperature is to use a precision crystal oscillator (operating at a very high frequency, for example 20, 40 or 60MHz) to measure the frequency of the ring by measuring the time (oscillator clock cycles) to count to a defined number of ring cycles.

### 8.6 Interaction between Multiple Gyroscopes

The resonant frequency of the gyroscope is nominally 14kHz. If multiple gyroscopes are operated together, there is the possibility of interaction between them, causing a beat frequency to become apparent on their outputs.

In multi-axis applications, it is recommended that different frequency variants are selected (V, L and M) and that the CRH03's are isolated both electrically and mechanically.

Electrical isolation can be achieved by using a separate low drop out linear power regulator for each gyroscope.

Mechanical isolation can be achieved by mounting the gyroscopes as far apart from each-other as possible or by the use of anti-vibration or compliant mounts.

### 8.7 Allan Variance Current Consumption with Temperature

This section shows the typical Allan Variance graphs for the CRH03's at constant temperature.

Figure 8.2 shows a general Allan Variance graph as a guide for calculating bias instability and Angle Random Walk. The Angle Random Walk is calculated as follows:

- A line is drawn tangential to the Allan Variance graph at a  $-1/2$  gradient (on a log-log plot).
- The line is extrapolated to intercept the 1 second correlation point ( $\tau$ ). The value at the intercept point is noted.
- The Angle Random Walk is this value, in units of degrees/hour, divided by 60. In the Figure 8.2, the line intercept the 1 second correlation time at  $0.57^\circ/\text{hr}$ , giving an Angle Random Walk of  $0.01^\circ/\sqrt{\text{hr}}$ .

The bias instability is value at the minimum part of the Allan Variance plot, usually between correlation times of 10s and 100s. In the Figure 8.2, the bias instability is approximately  $0.05^\circ/\text{hr}$ .

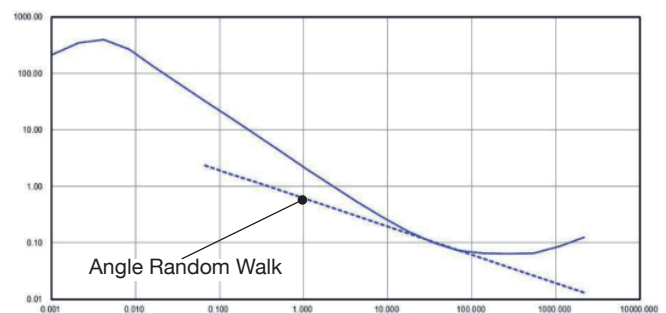
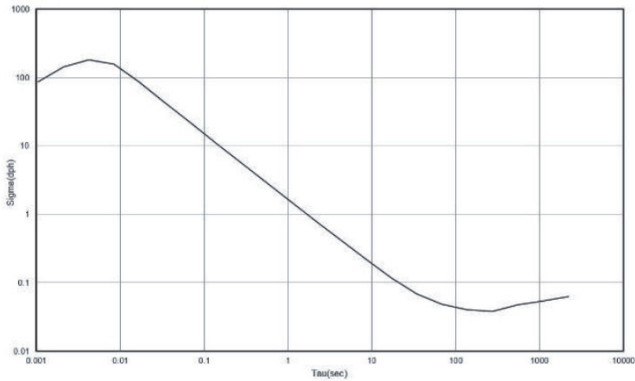
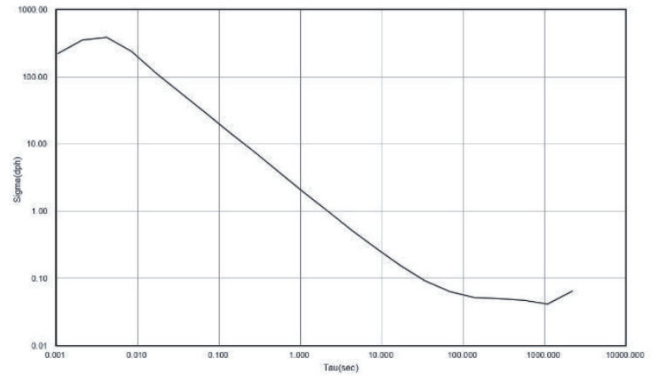


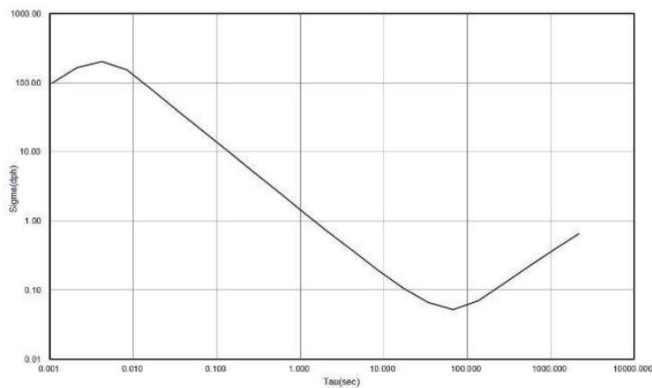
Figure 8.2 Derivation of Angle Random Walk and Bias Instability



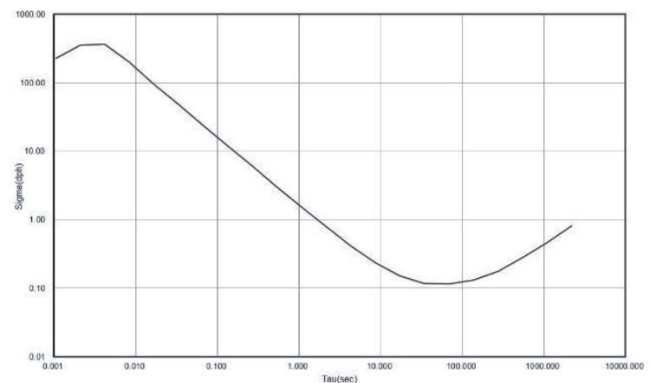
**Figure 8.3 CRH03-010 Allan Variance Performance (w.r.t. 25°C)**



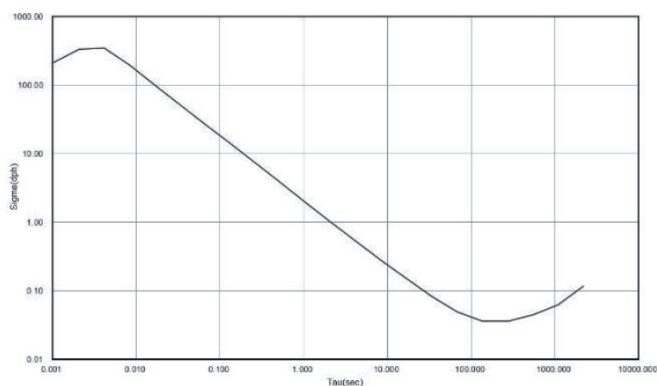
**Figure 8.6 CRH03-200 Allan Variance Performance (w.r.t. 25°C)**



**Figure 8.4 CRH03-025 Allan Variance Performance (w.r.t. 25°C)**



**Figure 8.7 CRH03-400 Allan Variance Performance (w.r.t. 25°C)**

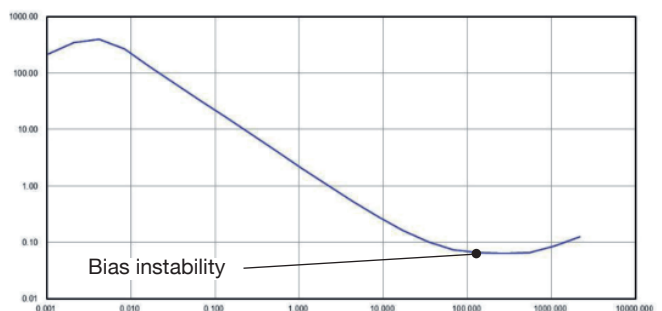


**Figure 8.5 CRH03-100 Allan Variance Performance (w.r.t. 25°C)**

### 8.8 Bias Instability

Bias instability value is used for the lowest value in Allan Variance data.

The bias instability value of this datasheet is measured using 24 bits ADC at 25°C condition.



### 8.9 Rate Output when over Range Input

If CRH03 is operated outside of its specified angular rate range, the sensor will not be damaged but the output will saturate. Once the over range is removed, CRH03 will return to its normal operational state within 2 seconds.

### 8.10 Soldering

CRH03 should not be exposed to temperatures in excess of 100°C. This includes during follow on assembly and reflow soldering operations.

### 8.11 Input Protection

CRH03 does not have reverse or over voltage protection on any input.

### 8.12 Disposal Processing

In the event of scrappage, CRH03 should be disposed of as industrial waste and in accordance with local regulations.

### 8.15 Notice

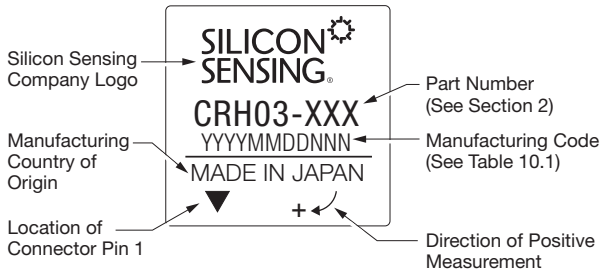
Specifications are subject to change without notification for the purpose of product improvement.

## 9 Glossary of Terms

ADC	Analogue to Digital Converter
ARW	Angular Random Walk
BW	Bandwidth
C	Celsius or Centigrade
DAC	Digital to Analogue Converter
DPH	Degrees Per Hour
DPS	Degrees Per Second
DRIE	Deep Reactive Ion Etch
EMC	Electro-Magnetic Compatibility
ESD	Electro-Static Damage
F	Farads
hr	Hour
HBM	Human Body Model
Hz	Hertz, Cycle Per Second
k	Kilo
MEMS	Micro-Electro Mechanical Systems
mV	Millivolts
NEC	Not Electrically Connected
NL	Scale Factor Non-Linearity
PD	Primary Drive
PP	Primary Pick-Off
RC	Resistor and Capacitor filter
s	Seconds
SF	Scale Factor
SMT	Surface Mount Technology
SOG	Silicon On Glass
SD	Secondary Drive
SP	Secondary Pick-Off
T.B.A.	To Be Announced
T.B.D.	To Be Described
V	Volts
VSG	Vibrating Structure Gyroscope
w.r.t.	With Respect To



### 10 Part Markings



C.G. 18898

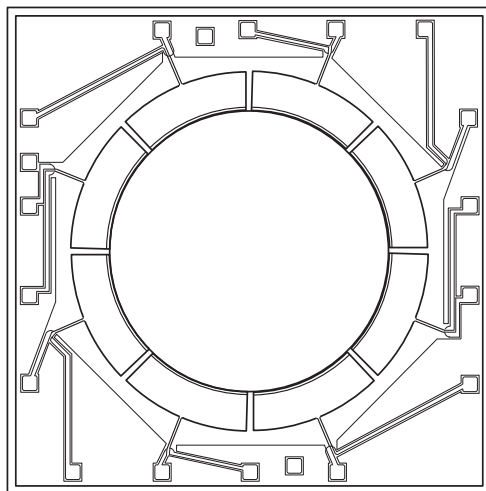
**Figure 10.1 Part Marking**

Data	Code	Range
Manufacture Year	YYYY	0000 - 9999
Manufacture Month	MM	01 - 12
Manufacture Day	DD	01 - 31
Manufacture Number	NNN	001 - 999

**Table 10.1 Manufacturing Code**

### 11 Silicon MEMS Ring Sensor (Gyro)

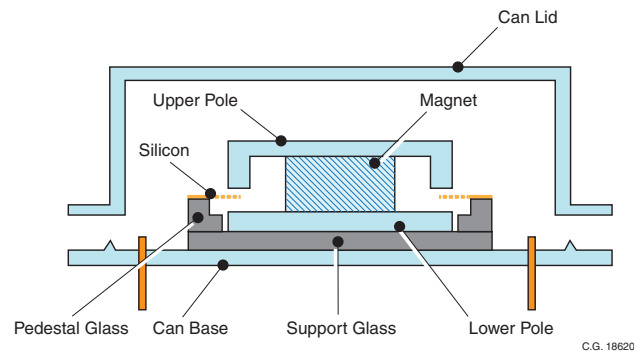
The silicon MEMS ring is 6mm diameter by 100µm thick, fabricated by Silicon Sensing Systems using a DRIE (Deep Reactive Ion Etch) bulk silicon process. The ring is supported in free-space by eight pairs of symmetrical ‘dog-leg’ shaped legs which support the ring from the supporting structure on the outside of the ring.



C.G. 18619

**Figure 11.1 Silicon MEMS Ring**

The bulk silicon etch process and unique patented ring design enable close tolerance geometrical properties for precise balance and thermal stability and, unlike other MEMS gyros, there are no small gaps to create problems of interference and stiction. These features contribute significantly to CRH03’s bias and scale factor stability over temperature, and vibration immunity. Another advantage of the design is its inherent immunity to acceleration induced rate error, or ‘g-sensitivity’.



C.G. 18620

**Figure 11.2 MEMS VSG3 Sensor**

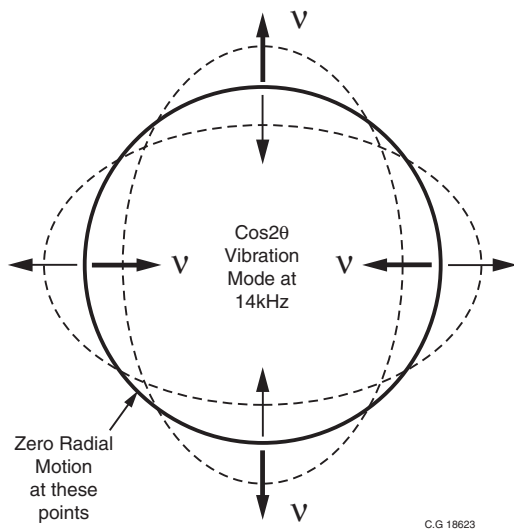
The ring is essentially divided into 8 sections with two conductive tracks in each section. These tracks enter and exit the ring on the supporting legs. The silicon ring is bonded to a glass pedestal which in turn is bonded to a glass support base. A magnet, with upper and lower poles, is used to create a strong and uniform magnetic field across the silicon ring. The complete assembly is mounted within a hermetic can.

The tracks along the top of the ring form two pairs of drive tracks and two pairs of pick-off tracks. Each section has two loops to improve drive and pick-off quality.

One pair of diametrically opposed tracking sections, known as the Primary Drive PD section, is used to excite the cos2θ mode of vibration on the ring. This is achieved by passing current through the tracking, and because the tracks are within a magnetic field causes motion on the ring. Another pair of diametrically opposed tracking sections is known as the Primary Pick-off PP section is used to measure the amplitude and phase of the vibration on the ring. The Primary Pick-off sections are in the sections 90° to those of the Primary Drive sections. The drive amplitude and frequency is controlled by a precision closed loop electronic architecture with the frequency controlled by a Phase Locked Loop (PLL), operating with a

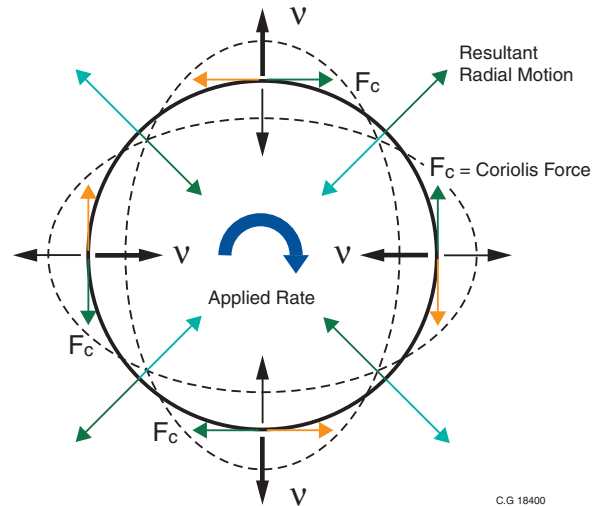


Voltage Controlled Oscillator (VCO), and amplitude controlled with an Automatic Gain Control (AGC) system. The primary loop therefore establishes the vibration on the ring and the closed loop electronics is used to track frequency changes and maintain the optimal amplitude of vibration over temperature and life. The loop is designed to operate at about 14kHz.



**Figure 11.3 Primary Vibration Mode**

Having established the  $\cos 2\theta$  mode of vibration on the ring, the ring becomes a Coriolis Vibrating Structure Gyroscope. When the gyroscope is rotated about its sense axis the Coriolis force acts tangentially on the ring, causing motions at  $45^\circ$  displaced from the primary mode of vibration. The amount of motion at this point is directly proportional to the rate of turn applied to the gyroscope. One pair of diametrically opposed tracking sections, known as the Secondary Pick-off SP section, is used to sense the level of this vibration. This is used in a secondary rate nulling loop to apply a signal to another pair of secondary sections, known as the Secondary Drive SD. The current applied to the Secondary Drive to null the secondary mode of vibration is a very accurate measure of the applied angular rate. All of these signals occur at the resonant frequency of the ring. The Secondary Drive signal is demodulated to baseband to give a voltage output directly proportional to the applied rate in free space.



**Figure 11.4 Secondary Vibration Mode**

The closed loop architecture on both the primary and secondary loops results in excellent bias, scale factor and non-linearity control over a wide range of operating environments and life. The dual loop design, introduced into this new Sensor Head design, coupled with improved geometric symmetry results in excellent performance over temperature and life. The discrete electronics employed in CRH03, ensures that performance is not compromised.

# CRH03 Series Technical Datasheet

High Performance Analogue Angular Rate Sensor



[www.siliconsensing.com](http://www.siliconsensing.com)

## Notes

Silicon Sensing Systems Limited  
Clifford Road Southway  
Plymouth Devon  
PL6 6DE United Kingdom

T: +44 (0)1752 723330  
F: +44 (0)1752 723331  
E: [sales@siliconsensing.com](mailto:sales@siliconsensing.com)  
W: [siliconsensing.com](http://siliconsensing.com)

Silicon Sensing Systems Japan Limited  
1-10 Fuso-Cho  
Amagasaki  
Hyogo 6600891 Japan

T: +81 (0)6 6489 5868  
F: +81 (0)6 6489 5919  
E: [sssj@spp.co.jp](mailto:sssj@spp.co.jp)  
W: [siliconsensing.com](http://siliconsensing.com)

Specification subject to change without notice.

© Copyright 2021  
Silicon Sensing Systems Limited  
All rights reserved.

Printed in England 02/2021  
Date 17/02/2021

CRH03-00-0100-132 Rev 2  
DCR No. 710018732